

E-245

Esmaltado y cristal blanco
Una campana, tres soluciones
White enamel and glass
One Hood, Three Solutions



Modelos / Models

S.E.C. System® Motor Interior / Interior Motor

Front. (cm)	Motor	Ø tubo	Clas. Ener.	Ref.
100	V.1130 eco PLUS	Ø150	A	010035

Opcionales / Options

Kits de recirculación. Ver página 210
Activated carbon filters kit. See page 210

Cambio a LED cálido de 3000K. Suministrado con la campana
LED change to warm light LED 3000K. Available only at the factory

Este modelo puede solicitarse bajo pedido SIN ILUMINACIÓN.
This model can be manufactured WITHOUT LIGHTING on request

Conjunto botonera INOX de encastre a pared.
Solo suministrado con la campana.
Stainless steel button panel set for embedding into the wall.
Available only at the factory.

Conjunto botonera BLANCO de encastre a pared.
Solo suministrado con la campana.
White enamel button panel set for embedding into the wall.
Available only at the factory.

Notas / Notes



Para otras alturas, consultar con nuestra división técnica.
For other heights, please check with our Technical department.



Opcional / Options
Inox / Stainless Steel
Esmaltado blanco / White

INCLUIDO / INCLUDED

Este modelo incorpora de serie 2 m de tubo de extracción de humos espiral 150 circular
This model comes with 2 m of 150 diameter circular spiral extractor flue as standard.

Notas instalación / Installation Notes Opción recirculación / Option of recirculation

Distancia entre campana y pared mínimo 2 m.
Maximum distance between hood and Wall of 2 m.

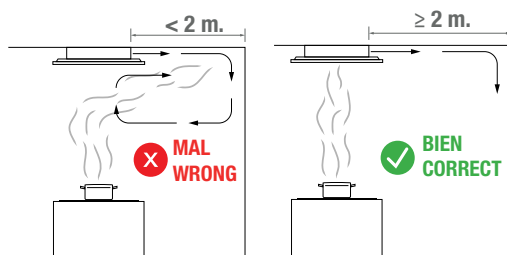

Esquemas medidas / Technical Drawings

Opción encastrada Built-in option

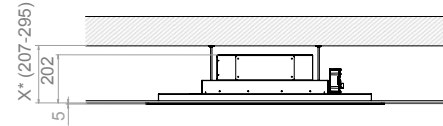
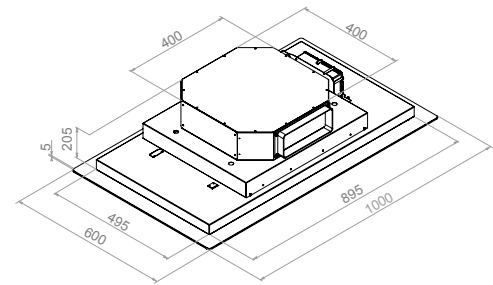

Medidas Encastre
Built in Sizes
116 920 x 520

Opción semi-encastrada Semi-built-in option

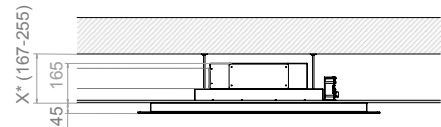
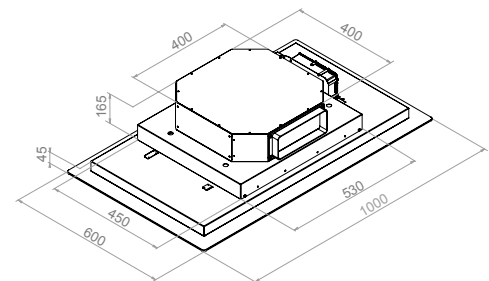

Medidas Encastre
Built in Sizes
116 850 x 470

Opción recirculación. Filtros de carbón activado de alta eficiencia Recirculation option High efficiency reactivated carbon filters

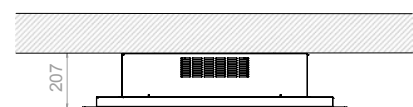
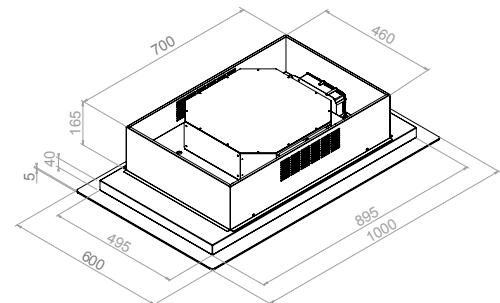

Acceso / Access WEB



E-245



Opción encastrada
Built-in option



Opción semi-encastrada
Semi-built-in option



Opción recirculación.
Filtros de carbón de alta eficiencia
Recycling option - Activated carbon filter